

MAC823

HIGH PERFORMANCE AC GOLF CAR
MOTOR (10-000823)

NAVITAS
VEHICLE SYSTEMS



MOTOR FEATURES:

- High Quality AC Induction Motor
- External Speed Sensor
- Internal Temperature Sensor
- Steel And Aluminum Construction
- High Torque with High Speed

APPLICATIONS:

- Golf Car
- Utility Vehicle
- Personnel Carriers
- UTV
- Hunting buggies

MOTOR DATA:

Type of Motor	AC Induction
Rated Power	5 KW
Rated Voltage	34 V (AC) RMS
Rated Current	113A
Rated Speed	2785 RPM
Frequency	0-200 Hz

RPM	0~5875 RPM
Splines	10
Insulation Class	H
Protection Mode	IP44
Static Torque	46 Nm

MAC823

HIGH PERFORMANCE AC GOLF CAR
MOTOR WITH BRAKE (10-000823)

NAVITAS
VEHICLE SYSTEMS

10-000823 5KW AC MOTOR

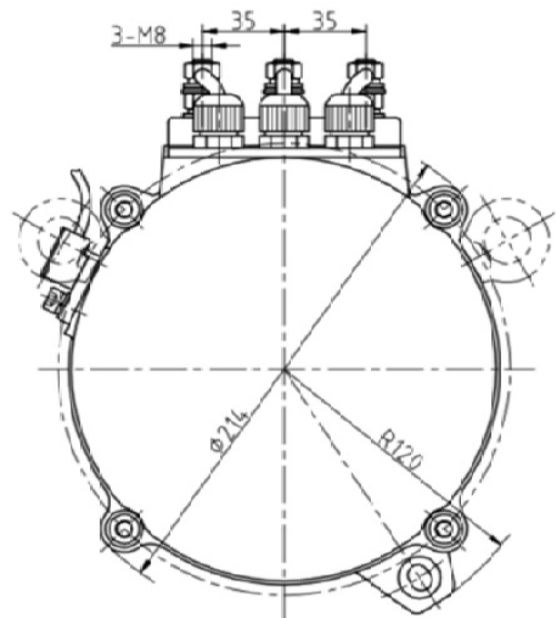
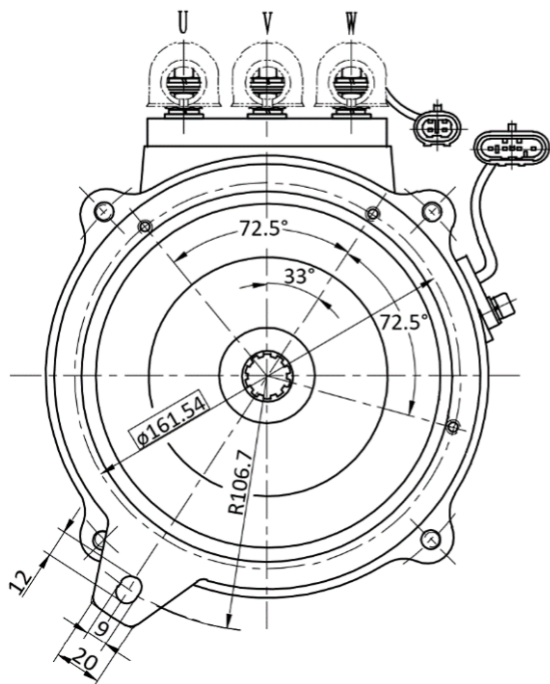
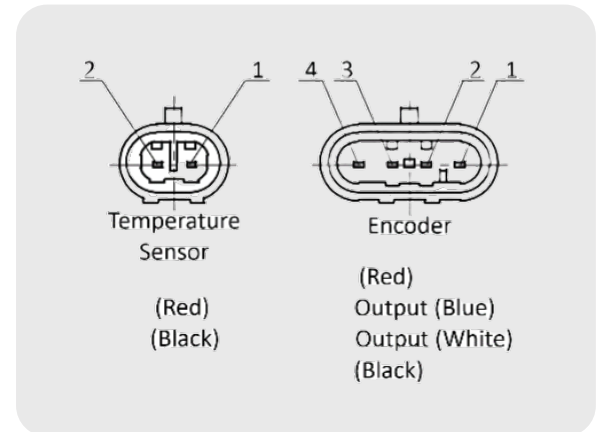
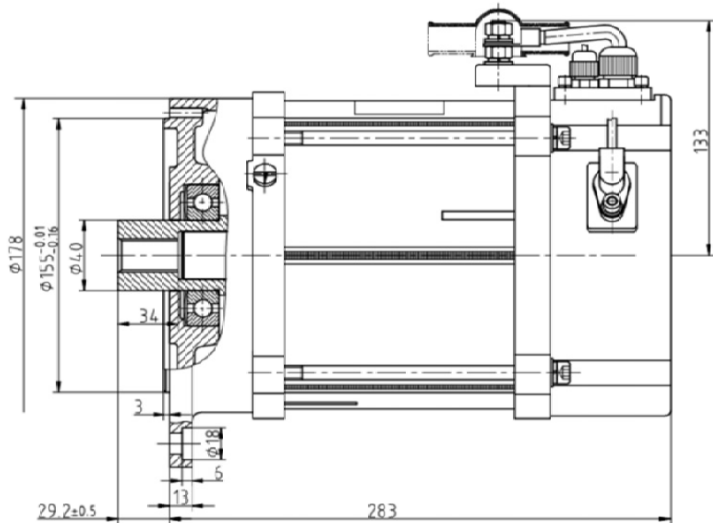

NOTE: Specifications subject to change without notice