

MAC976

HIGH PERFORMANCE AC GOLF CAR
MOTOR WITH BRAKE (10-000976)

NAVITAS
VEHICLE SYSTEMS



MOTOR FEATURES:

- High Quality AC Induction Motor
- External Speed Sensor
- Internal Temperature Sensor
- Steel And Aluminum Construction
- High Torque with High Speed

APPLICATIONS:

- Golf Car
- Utility Vehicle
- Personnel Carriers
- UTV
- Hunting buggies

MOTOR DATA:

Type of Motor	AC Induction
Rated Power	4 KW
Rated Voltage	34 V (AC) RMS
Rated Current	91A
Rated Speed	3600 RPM
Frequency	0-123 Hz

RPM	0~6800 RPM
Splines	19
Insulation Class	H
Protection Mode	IP44
Brake Voltage	48V \pm 10%
Static Torque	46 Nm

MAC976

HIGH PERFORMANCE AC GOLF CAR
MOTOR WITH BRAKE (10-000976)

NAVITAS
VEHICLE SYSTEMS

10-000976 4KW AC MOTOR WITH BRAKE

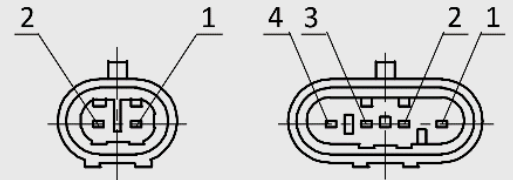
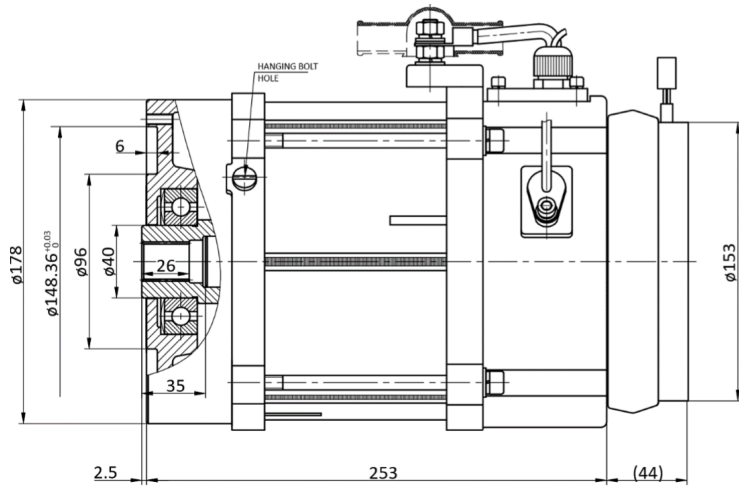

- 1 + (RED) ——— TEMPERATURE SENSOR
- 2 - (BLACK) ———
- 1 + (RED/YELLOW) ——— ENCODER
- 2 B Output (BLUE) ———
- 3 A Output (WHITE) ———
- 4 - (BLACK) ———

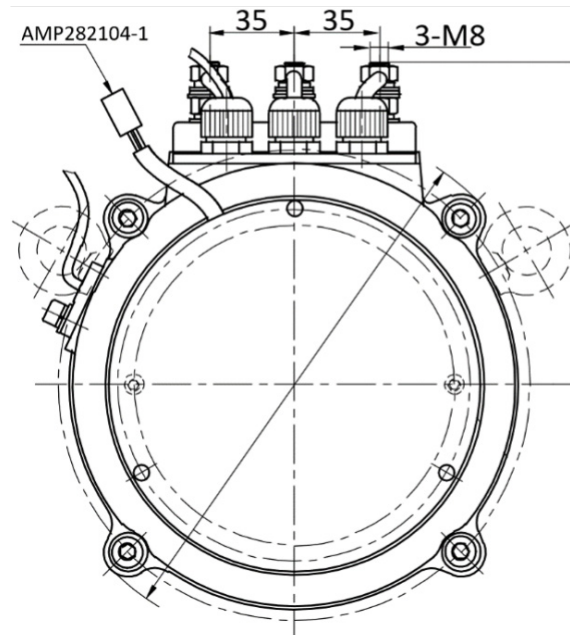
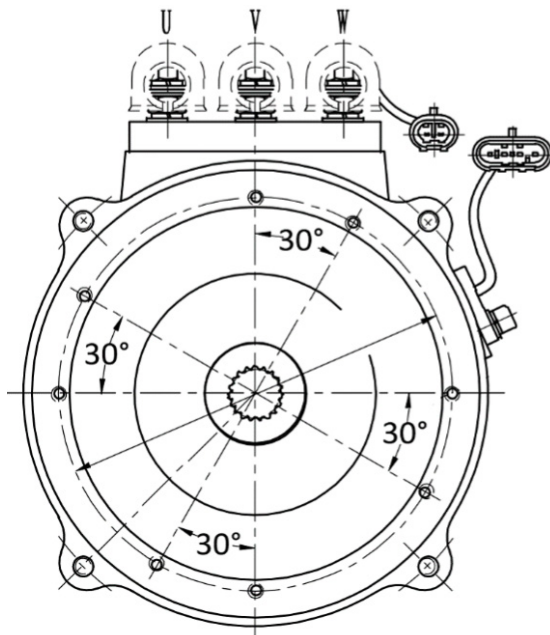

NOTE: Specifications subject to change without notice